



Features

- Small (10.4 x 6.0 x 2.2mm)
- Proven and robust silicon MEMS vibrating ring gyro and dual-axis accelerometer
- Excellent bias over temperature (1.75°/s, 30mg)
- Flat and orthogonal mounting options (CMS300 and CMS390)
- User selectable dynamic ranges (150°/s, 300°/s, 2.5g and 10g)
- Digital (SPI®) output mode
- User selectable bandwidth (Rate; 45, 55, 90 or 110Hz Acc; 45, 62, 95 or 190Hz)
- Range and bandwidth independently selectable for each axis
- Low power consumption (8mA) from 3.3V supply
- High shock and vibration rejection
- Temperature range -40 +125°C
- Hermetically sealed ceramic LCC surface mount package for temperature and humidity resistance
- Integral temperature sensor
- RoHS compliant

Applications

- Measurement and control
- Navigation and personal navigation
- Inertial Measurement Units
- Inclinometers/tilt sensors
- Low cost AHRS and attitude measurement
- Levelling
- Robotics

1 General Description

Orion™ is a new family of integrated MEMS inertial 'Combi-Sensors' from Silicon Sensing, combining high performance single-axis angular rate and dual-axis linear acceleration measurement in a small surface mounted package. It comprises two discrete MEMS sensing devices with a dedicated control ASIC in a single ceramic LCC package. Sensor data is output onto a SPI® digital interface. Dynamic range and bandwidth of all three channels can be independently selected by the user for optimal sensitivity. Two package configurations are available; part numbers CMS300 (Flat) and CMS390 (Orthogonal).

This datasheet relates to the CMS300 part. CMS300 provides out-of-plane (Z-axis perpendicular to PCBA) angular rate sensing and two in-plane axes (X and Y parallel to PCBA) of linear acceleration sensing. CMS300 is supplied as a PCBA surface mountable standard LCC ceramic packaged device which is hermetically sealed providing full environmental protection and EMC shielding.

Angular rate is accurately measured using Silicon Sensing's proven 5th generation VSG5 Silicon MEMS ring gyroscope with multiple piezoelectric actuators and transducers. The 3mm ring is driven into resonance by a pair of primary drive actuators. Primary pick-off transducers provide closed loop control of ring amplitude and frequency. Pick-off transducers detect rate induced motion in the secondary axis, due to Coriolis force effects, the amplitude of which is proportional to angular velocity.

Precise linear acceleration sensing is achieved by a Silicon MEMS detector forming an orthogonal pair of sprung masses. Each mass provides the moving plate of a variable capacitance formed by an array of interlaced 'fingers'. This structure also provides critical damping to prevent resonant gain. Linear acceleration results in a change of capacitance which is measured by demodulation of the square wave excitation. The sensor has high linearity and shock resistance.

ASIC processing includes rate and acceleration bias, bias temperature sensitivity and scale factor sensitivity trim for all three sensors allowing sensor calibration over temperature in production.

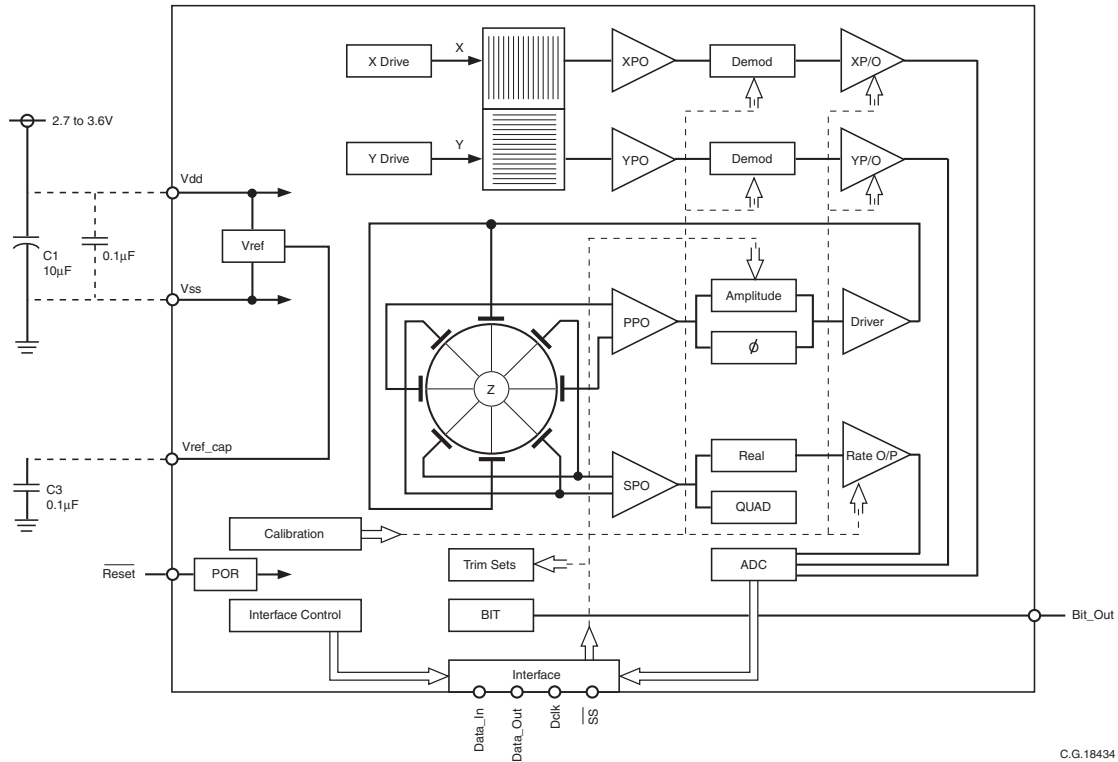

C.G.18434

Figure 1.1 CMS300 Functional Block Diagram

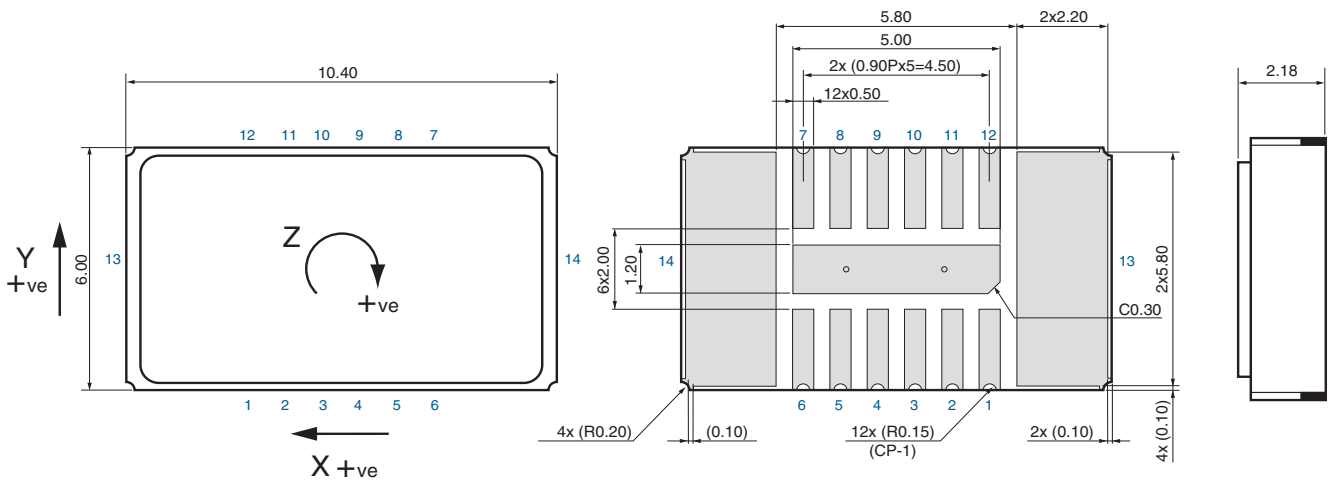

All dimensions in millimetres.

C.G.18495

Figure 1.2 CMS300 Overall Dimensions

2 Ordering Information

Part Number	Sense Axes	Description	Measurement Range		Modes	Overall Dimensions	Supply Voltage
			°/s	X,Y g			
CMS300		Single-axis (Z) rate and dual-axis (X,Y) MEMS Combi-Sensor. Z-axis perpendicular to the host PCBA.	User selectable ±150 & ±300	User selectable ±2.5g & ±10g	Digital SPI®	10.4x6.0x2.2H	2.7 ~ 3.6
CMS390		Single-axis (Z) rate and dual-axis (X,Y) MEMS Combi-Sensor. Z-axis parallel to the host PCBA.	User selectable ±150 & ±300	User selectable ±2.5g & ±10g	Digital SPI®	10.4x2.7x6.7H	2.7 ~ 3.6
CMS300-02-0302		Evaluation Board for the CMS300 Combi-Sensor (includes the sensor). See Section 9 for more details.	User selectable ±150 & ±300	User selectable ±2.5g & ±10g	Digital SPI®	34.0x26.0x4.0H	2.7 ~ 3.6
CMS390-02-0305		Evaluation Board for the CMS390 Combi-Sensor (includes the sensor). See Section 9 for more details.	User selectable ±150 & ±300	User selectable ±2.5g & ±10g	Digital SPI®	34.0x26.0x8.5H	2.7 ~ 3.6

3 Specification

Unless stated otherwise, the following specification values assume Vdd = 3.15V to 3.45V and an ambient temperature of +25°C. 'Over temperature' refers to the temperature range -40°C to +125°C.

Parameter	Minimum	Typical	Maximum	Notes
Rate Channel:				
Dynamic Range		±150°/s, ±300°/s		User selectable
Resolution	–	0.005°/s (±150°/s) 0.01°/s (±300°/s)	0.05°/s	SPI® scaling: ±150°/s = 204.8 lsb/(°/s), ±300°/s = 102.4 lsb/(°/s)
Scale factor variation over, temperature, environment and life	–	–	±2.75%	–
Scale factor variation over temperature	–	<±1%	±2.0%	–
Scale factor non-linearity error	–	<±0.15°/s (±150°/s) <±0.3°/s (±300°/s)	<±0.30°/s (±150°/s) <±0.75°/s (±300°/s)	Deviation from best fit straight line over operating range
Bias over temperature, environment and life	–	–	±2.75°/s	–

Specification Continued

Parameter	Minimum	Typical	Maximum	Notes
Bias variation with temperature	–	±1.0%/s	±1.75%/s	–
Initial bias setting	–	±0.5%/s	±1.75%/s	At constant temperature (25°C)
Bias switch on repeatability	–	±0.03%/s	±0.15%/s	At constant ambient temperature
Bias drift with time after switch on	–	±0.02%/s	±0.2%/s	At constant ambient temperature
Bias drift with temperature ramp	–	±0.01%/s/°C	±0.06%/s/°C	At 5°C/min
Acceleration sensitivity	–	±0.025%/s/g	±0.1%/s/g	–
Noise	–	0.06%/s	0.1%/s	RMS to 45Hz
Frequency response	40Hz 50Hz 80Hz 95Hz	45Hz 55Hz 90Hz 110Hz	50Hz 60Hz 100Hz 125Hz	-3dB, second order user selectable
Maximum phase delay	–	–	11ms (BW 45Hz)	–
Mechanical resonance	–	22kHz	–	Frequency of operation
Acceleration Channels:				
Dynamic range	±2.5g, ±10g			User selectable
Resolution	–	0.079mg (2.5g) 0.313mg (10g)	1mg	SPI® scaling: ±2.5g = 12800lsb/g ±10g = 3200lsb/g
Scale factor variation temperature environment and life	–	–	±3%	–
Scale factor variation over temperature	–	±1%	±2.5%	–
Scale factor non-linearity error	–	3mg (2.5g) 5mg (10g)	12.5mg (2.5g) 50mg (10g)	50mg over range ±8g NL error is proportional to acceleration cubed
Orthogonality	–	±0.1°	–	Relative to the other acceleration sensor
Noise	–	1mg	2mg	RMS in 45Hz
Frequency response	40Hz 55Hz 85Hz 170Hz	45Hz 62Hz 95Hz 190Hz	50Hz 70Hz 105Hz 210Hz	-3dB, second order user selectable
Maximum phase delay	–	–	10ms (BW 45Hz)	–
Mechanical resonance	–	2.9kHz	–	MEMS resonance

Specification Continued

Parameter	Minimum	Typical	Maximum	Notes
Bias (±2.5g):				
Turn on bias	–	–	±30mg	At 25 ±5°C (see Note 1)
Bias variation with temperature	–	–	±30mg	-40°C to +85°C normalised to +25°C
Bias over temperature, environment and life	–	–	±75mg	40°C to +85°C normalised to +25°C
Bias switch on repeatability	–	±0.3mg	±1.5mg	At constant temperature
Bias drift with time after switch on	–	–	±10mg	During 1 hour at constant temperature
Bias drift with temperature ramp	–	±0.3mg/°C	±1.5mg/°C	At 5°C/min
Bias (±10g):				
Turn on bias	–	–	±75mg	At 25 ±5°C (see Note 1)
Bias variation with temperature	–	±50mg	±75mg	-40°C to +85°C normalised to +25°C
Bias over temperature, environment and life	–	–	±125mg	–
Bias switch on repeatability	–	±0.3mg	±2.0mg	At constant temperature
Bias drift with time after switch on	–	–	±10mg	During 1 hour at constant temperature
Bias drift with temperature ramp	–	±0.3mg/°C	±1.5mg/°C	At 5°C/min
Temperature Sensors:				
Scale factor	–	–	±3%	11lsb/°C
Offset	–	–	±20°C	–
Repeatability	–	–	±5°C	–
Start Up:				
Time to full performance	–	150ms	300ms	–
Self Test (CBIT) Rate Sensor:				
At 25°C	+54%/s (150%/s) +90%/s (300%/s)	+64%/s (150%/s) +107%/s (300%/s)	+74%/s (150%/s) +125%/s (300%/s)	–
Variation with temperature	–	<=±0.6%/s (150%/s) <=±1.2%/s (300%/s)	–	-40°C to +125°C normalised to +25°C

Specification Continued

Parameter	Minimum	Typical	Maximum	Notes
Self Test (CBIT) Acceleration Sensors:				
At 25°C	+1.0g (2.5g) +4.7g (10g)	+1.25g (2.5g) +6.2g (10g)	+1.50g (2.5g) +7.7g (10g)	–
Variation with temperature	–	<=±0.03g (2.5g) <=±0.1g (10g)	–	-40°C to +125°C normalised to +25°C
Physical:				
Mass	–	0.4grams	–	–
Rate Sensor misalignment (Cross-axis Sensitivity)	–	–	±1.5%	Alignment of sensing element to package mounting face
Acceleration Sensor misalignment (Cross-axis Sensitivity)	–	–	±1.5%	Alignment of sensor to package
Environmental:				
Temperature (Operating)	-40°C	–	+125°C	–
Temperature (Storage)	-55°C	–	+150°C	–
Humidity	–	–	90% RH	Non-condensing
Vibration rectification error	–	0.001°/s/g ² _{rms}	0.003°/s/g ² _{rms}	8.85g _{rms} stimulus, 10Hz to 5kHz, random
Vibration induced noise	–	0.06°/s _{rms} /g ² _{rms}	0.072°/s _{rms} /g ² _{rms}	8.85g _{rms} stimulus, 10Hz to 5kHz, random
Electrical:				
Supply voltage	2.7V	3.3V (nom)	3.6V	–
	3.15V	3.3V (nom)	3.45V	Full specification
Current consumption (inrush - during start-up)	–	–	8.0mA	Excluding charging decoupling capacitors
Current consumption (operating - after start-up)	–	–	8.0mA	–
Interface:				
SPI® message rate	1Hz	1kHz	10kHz	–
SPI® clock rate	100kHz	1MHz	7MHz	–

4 Absolute Minimum/Maximum Ratings

	Minimum	Maximum
Angular Velocity:		
Powered (saturated)	–	150,000°/s
Unpowered	–	150,000°/s
Angular Acceleration:		
Powered (saturated)	–	>10,000°/s ²
Linear Acceleration (any axis):		
Powered	–	1,000g 1ms 1/2 sine
Unpowered	–	10,000g 0.5ms
Operating	–	95g 6ms 1/2 sine
Electrical:		
Vdd	-0.3V	+4.0V
ESD protection	–	2kV HBM 250V CDM
EMC radiated	–	200V/m 14kHz to 1.8GHz
Duration of short circuit on any pin (except Vdd)	–	100 seconds
Temperature:		
Operating	-40°C	+125°C
Max storage (survival)	-55°C	+150°C
Humidity	–	90% RH non-condensing
Life:		
Unpowered	15 years	–
Powered	12,000 hours	–

Notes:

1. Turn on bias is specified at 25 ±5°C and at a power supply voltage of 3.3V. At other power supply voltages, a bias change of typically 40mg/V can be expected.
2. Exposure to the Absolute Maximum Ratings for extended periods may affect performance and reliability.

5 Typical Performance Characteristics

Graphs showing typical performance characteristics for Orion™ are shown below:

Note: Typical data is with the device powered from a 3.3V supply.

Rate Channel

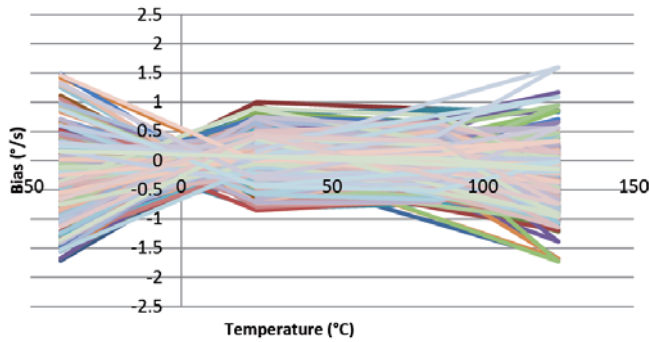

Figure 5.1 Bias vs Temperature
 (±300°/s)

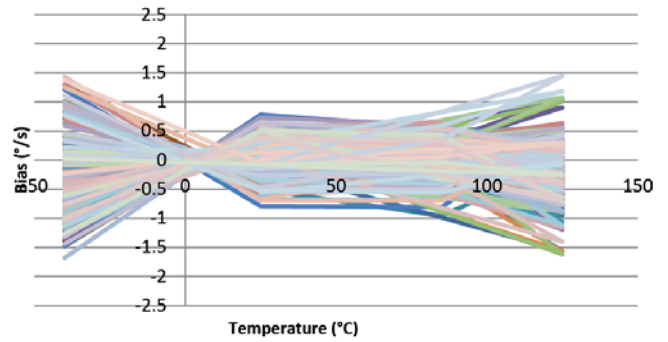

Figure 5.2 Bias vs Temperature
 (±150°/s)

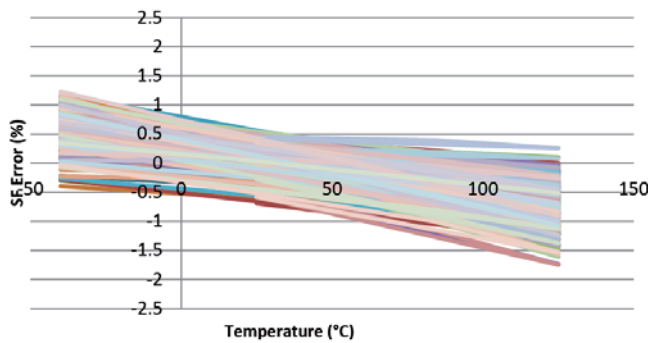

Figure 5.3 SF Error vs Temperature
 (±300°/s)

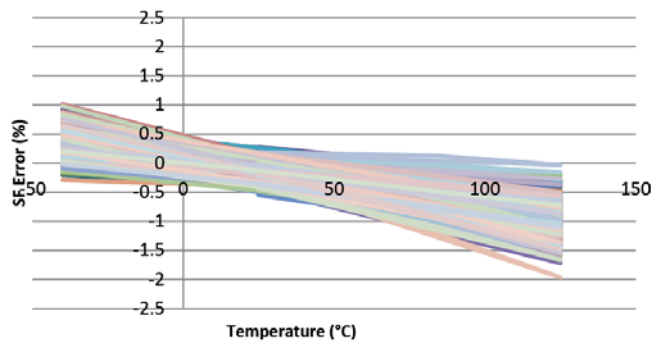

Figure 5.4 SF Error vs Temperature
 (±150°/s)

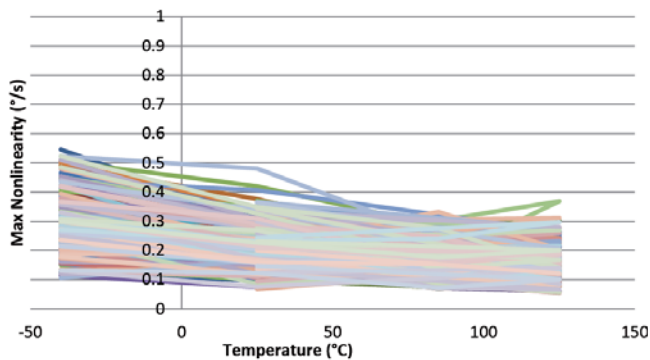

Figure 5.5 Non-linearity vs Temperature
 (±300°/s)

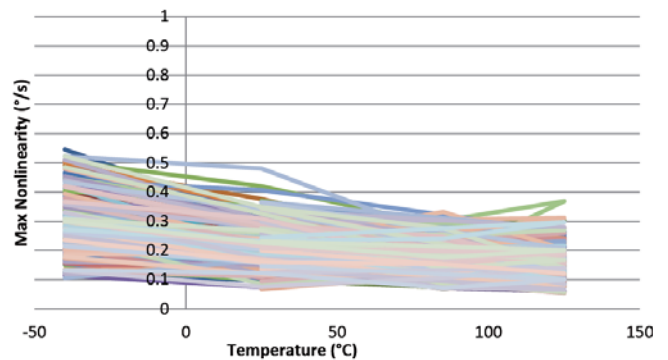

Figure 5.6 Non-linearity vs Temperature
 (±150°/s)

Typical Performance Characteristics Continued

Rate Channel

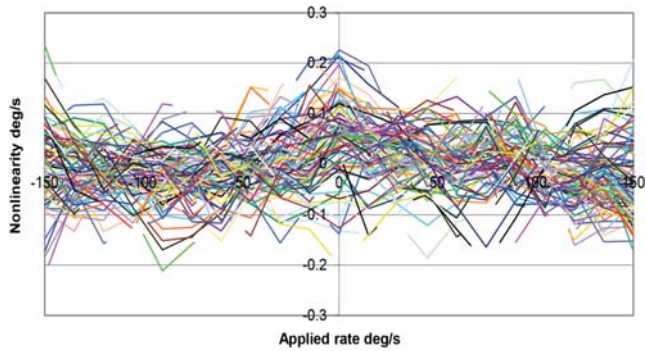

Figure 5.7 Non-linearity vs Applied Rate (at 25°C)

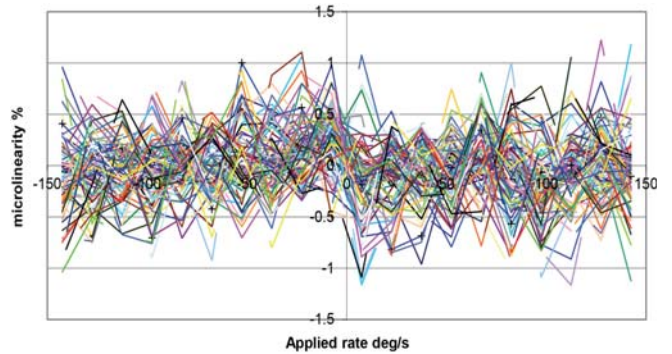

Figure 5.8 Micro-linearity vs Applied Rate (at 25°C)

Rate and Acceleration CBIT

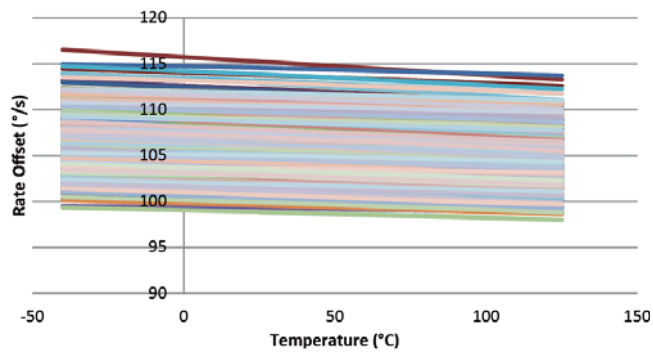

Figure 5.9 CBIT %s vs Temperature (±300°/s)

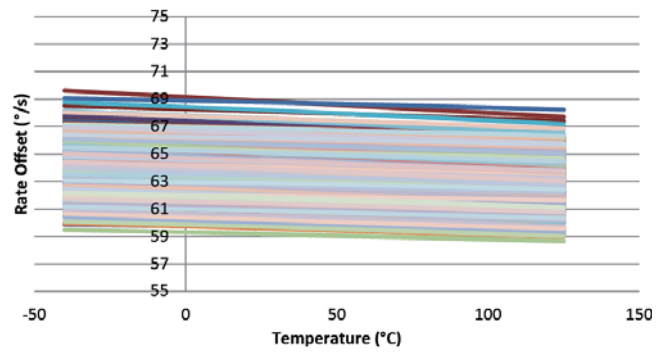

Figure 5.10 CBIT %s vs Temperature (±150°/s)

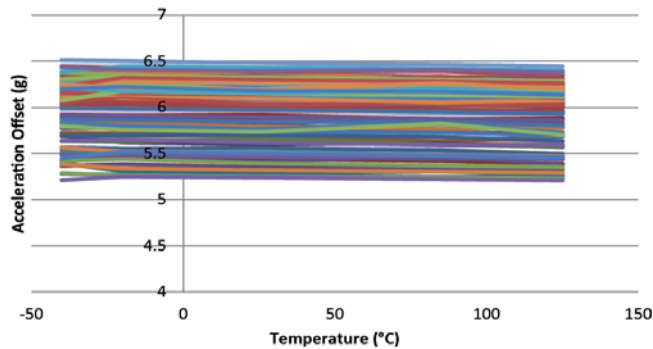

Figure 5.11 CBIT g vs Temperature (±10g)

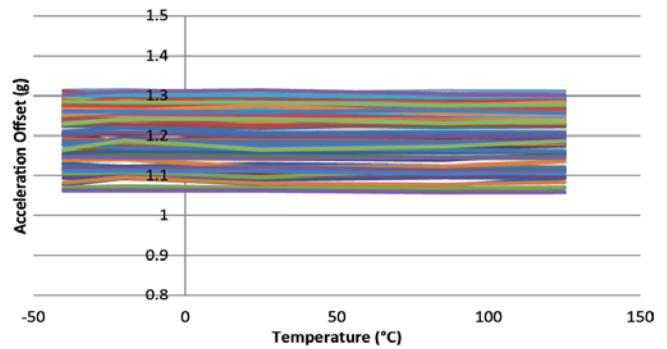

Figure 5.12 CBIT g vs Temperature (±2.5g)

Typical Performance Characteristics Continued
Acceleration Channels

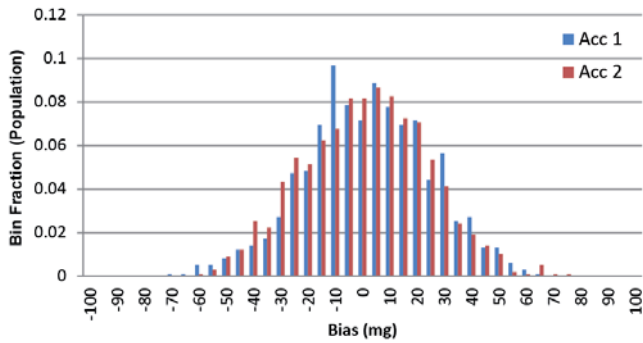

Figure 5.13 Acceleration Bias Distribution at 25°C (±10g)

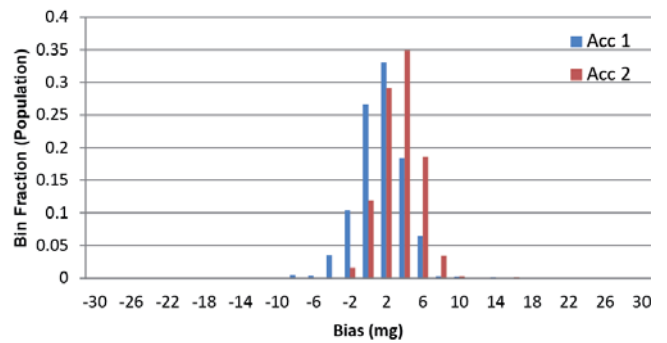

Figure 5.14 Acceleration Bias Distribution at 25°C (±2.5g)

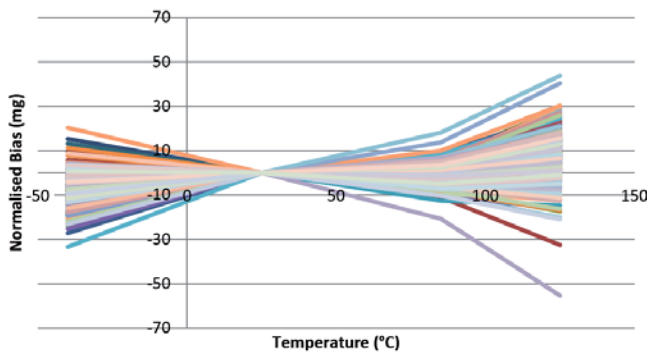

Figure 5.15 Accelerometer Y Bias vs Temperature (±10g)

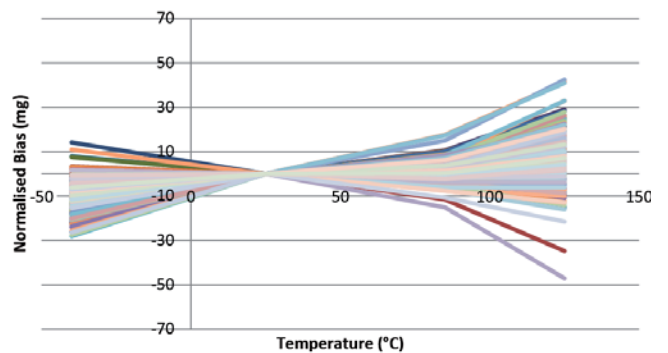

Figure 5.16 Accelerometer Y Bias vs Temperature (±2.5g)

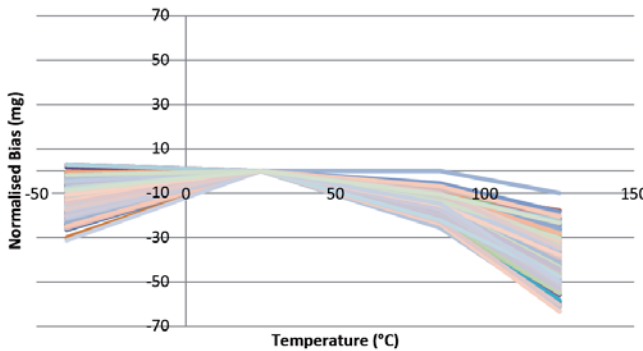

Figure 5.17 Accelerometer X Bias vs Temperature (±10g)

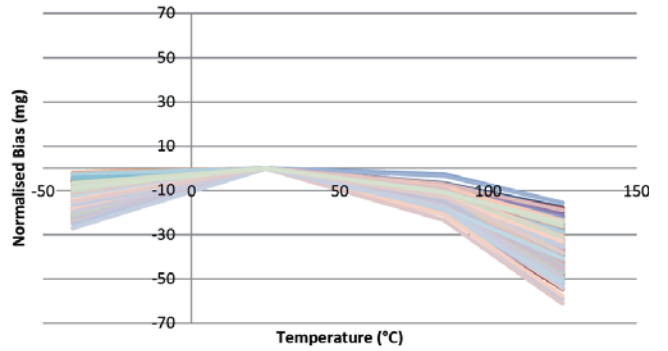

Figure 5.18 Accelerometer X Bias vs Temperature (±2.5g)

Typical Performance Characteristics Continued

Acceleration Channels

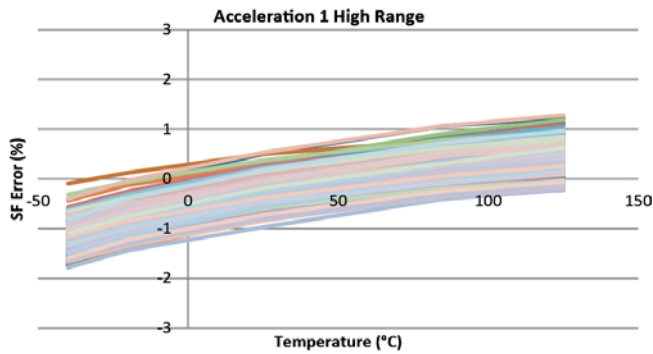

Figure 5.19 Accelerometer Y SF Error vs Temperature ($\pm 10g$)

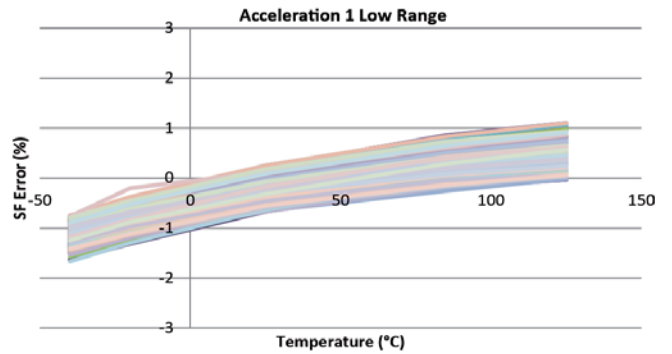

Figure 5.20 Accelerometer Y SF Error vs Temperature ($\pm 2.5g$)

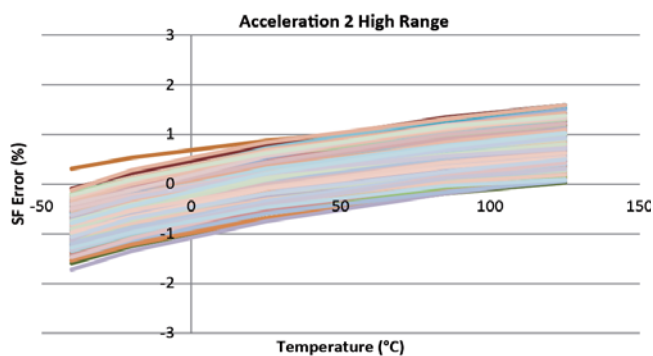

Figure 5.21 Accelerometer X SF Error vs Temperature ($\pm 10g$)

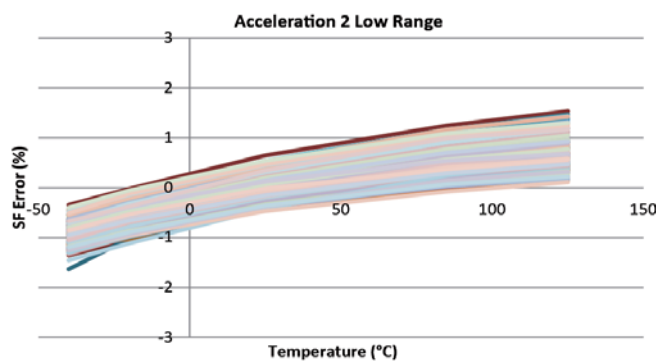

Figure 5.22 Accelerometer X SF Error vs Temperature ($\pm 2.5g$)

6 Glossary of Terms

ADC	Analogue to Digital Converter
ARW	Angular Random Walk
ASIC	Application Specific Integrated Circuit
BIT	Built-In Test
BW	Bandwidth
CBIT	Commanded Built-In Test
CDM	Charge Device Model
DAC	Digital to Analogue Converter
DRIE	Deep Reactive Ion Etch
DSBSC	Double Side-Band Suppressed Carrier Signal
EMC	Electro-Magnetic Compatibility
ESD	Electro-Static Damage
HBM	Human Body Model
IPC	Institute of Printed Circuits
LCC	Leadless Chip Carrier
LSB	Least Significant Bit
MEMS	Micro-Electro Mechanical Systems
NEC	Not Electrically Connected
PCBA	Printed Circuit Board Assembly
POR	Power On Reset
PPO	Primary Pick-Off
SF	Scale Factor
SMT	Surface Mount Technology
SOG	Silicon On Glass
SPI®	Serial Peripheral Interface A registered trademark of Motorola, Inc.
SPO	Secondary Pick-Off

7 Interface

Physical and electrical inter-connect and SPI® message information.

7.1 Physical and Electrical Interface, Pad Layout and Pinouts

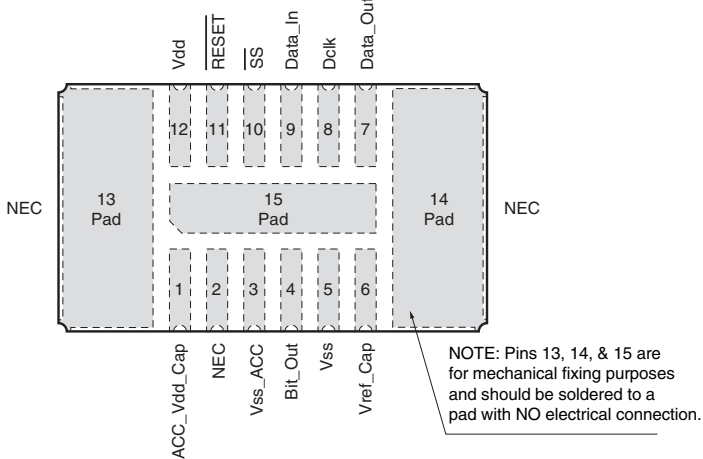

Figure 7.1 Pinout (Top View)

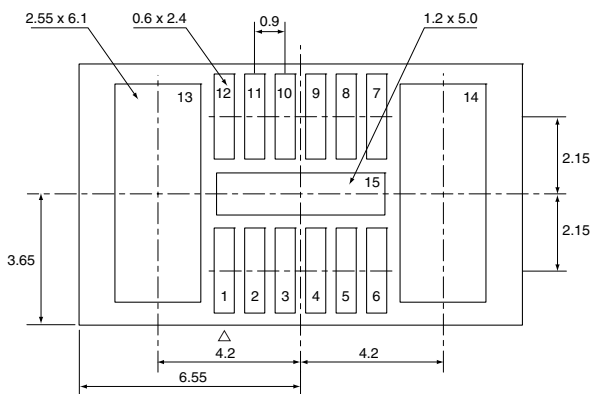

Figure 7.2 Recommended Pad Layout

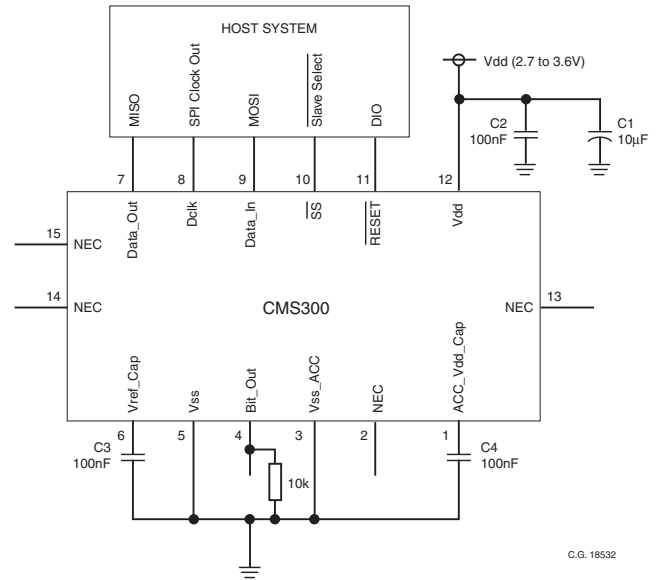

Figure 7.3 Peripheral Circuit

Note: The Orion accelerometers are capacitive sensors. The routing of signal tracks beneath the package (including power supply signals connecting to starpoints) can cause an offset in accelerometer bias. If such routing is unavoidable, the resulting offset can be removed by compensation at the higher system level.

Pin Number	Pin Name	Signal Direction	Pin Function
1	Acc_Vdd_Cap	–	Used to smooth supply to ACC MEMS. A 100nF X7R dielectric ceramic capacitor(C4) is recommended.
2	NEC	–	Not Electrically Connected.
3	Vss_Acc	–	Return connection for ACC applied power (0V)
4	BIT_Out	Output	BIT result, logical low indicates fault
5	Vss	–	Return connection for applied power (0V)
6	Vref_Cap	–	Used to decouple the internal voltage reference via an external capacitor. A 100nF X7R dielectric ceramic capacitor (C3) is recommended.
7	Data_Out	Output	SPI® Data Output line from Orion™. Only enabled when \overline{SS} is low. Tri-stated when \overline{SS} is high.
8	Dclk	Input	SPI® Clock Output line from the Host System. Internal Pull-up
9	Data_In	Input	Data Input line from the Host System. Internal Pull-up
10	\overline{SS}	Input	SPI_SELECT. Internal Pull-up
11	\overline{RESET}	Input	Used to reset the sensor, this will reload the internal calibration data. Active Low. Internal Pull-up
12	Vdd	–	Positive power supply to the sensor. Range from 2.7 to 3.6V. Should be decoupled with a 100nF X7R dielectric ceramic capacitor (C2), a bulk storage capacitor of 10 μ F should be nearby (C1).
Centre and Side Pads (13,14 & 15)	NEC	–	Not Electrically Connected. These pins provide additional mechanical fixing to the Host System and should be soldered to an unconnected pad.

Table 7.1 Input/Output Pin Definitions

Parameter	Minimum	Maximum	Units
Supply			
Supply voltage (functional)	2.7	3.6	V
Supply voltage (full specification)	3.15	3.45	V
Supply voltage limits	-0.3	4.0	V
Supply current	–	8	mA
Discretes			
Input voltage low	-0.5	0.3xVdd	V
Input voltage high	0.7xVdd	Vdd+0.5	V
Output voltage low	–	0.4	V
Output voltage high	0.8xVdd	–	V

Table 7.2 Electrical Characteristics

7.2 SPI® Digital Interface

This section defines the SPI® interface timing and the message types and formats to and from the Orion™ CMS300 sensor. It also defines the memory maps of the internal functional memory.

The SPI® interface, when selected, will be a 4-wire interface with the following signals:

Dclk	SPI® clock
Data_In	Message data input to sensor (MOSI)
Data_Out	Message data output by sensor (MISO)
SS	Select sensor

Signal electrical characteristics are defined in Table 7.3.

Parameter	Minimum	Maximum	Units
Input voltage low	-0.5	0.3xVdd	V
Input voltage high	0.7xVdd	Vdd+0.5	V
Output voltage low	-	0.4	V
Output voltage high	0.8xVdd	-	V
Output current	2.0	2.4	mA
Leakage current	-2	2	µA
Pull up current	10	50	µA

Table 7.3 SPI® Electrical Characteristics

The interface will transfer 4 bytes (32 bits) in each message. The message rate will be 1kHz (nom), (1Hz-min, 10kHz-max) with a SPI® clock frequency of 1MHz (nom), (100kHz-min, 7MHz-max).

The sensor will be a slave on the interface. All accesses shall use SPI® Mode 0.

Figure 7.4 below specifies the interface timing for correct operation.

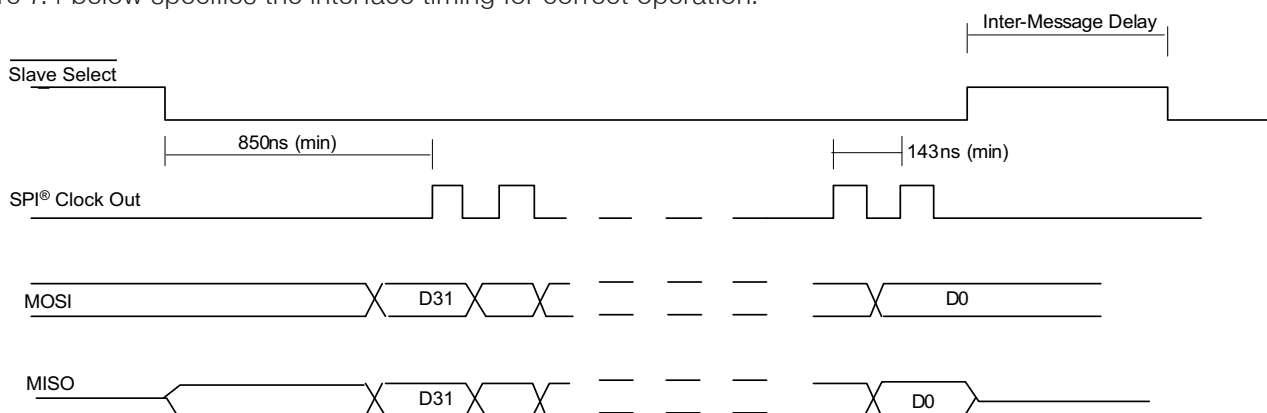

Figure 7.4 Timing Diagram

Note: The inter-message delay varies dependent on the command message type see section 7.2.1

7.2.1 Messages to Sensor (MOSI)

Table 7.4 outlines the command message types available from the host to the Orion™ sensor:

Message Type	Mode	Operation
Rate	Data Monitor	Request axis rate value in next message
Acceleration Y	Data Monitor	Request Y axis acceleration value in next message
Acceleration X	Data Monitor	Request X axis acceleration value in next message
Temperature	Data Monitor	Request Temperature value in next message
Device Configuration Status Request	Global	Request Status of device configuration e.g. BW, Range, Sense Direction etc in next message
Device Configuration Set	Global	This once only command will set the device configuration e.g. BW, Range, Sense Direction. This data will override the NVM selection and will remain set until a POR or Reset occurs. (see section 7.2.5)
BIT Status Request	Global	Request status of internal BIT flags in next message
NVM Read (including serial number)	Global	Output NVM data in next message. For user locations no access limitations. For serial number locations only read access is allowed
NVM write data	Global	Load write data into ASIC write data store (needs to be written before block write or any other write)
NVM Write	Global	Load Address selected with write data from above. Restricted access - see section 8.1 for NVM memory map
NVM Erase	Global	Erases Address selected. Restricted access - see section 8.1 for NVM memory map
REV	Global	Device revision state
INV REV	Global	Inverse of device revision state

Table 7.4 Command Message Types

Table 7.5 details the command bit format for messages to the Orion™ sensor:

Operation	Data Content D31:16	Mode D15:13	Address D12:8	D7 Note 1	D6	D5	D4	CRC D3:0 Note 2	Inter Message Delay	Notes
Rate	Not Used (set all to '0')	101	00000	CBIT_en	0	0	0	CRC	5.0µs(min)	-
Acceleration Y	Not Used (set all to '0')	101	00001	CBIT_en	0	0	0	CRC	5.0µs(min)	Refer to Fig 1.2 for axis and sense definition
Acceleration X	Not Used (set all to '0')	101	00010	CBIT_en	0	0	0	CRC	5.0µs(min)	Refer to Fig 1.2 for axis and sense definition
Temperature	Not Used (set all to '0')	101	00011	CBIT_en	0	0	0	CRC	5.0µs(min)	-
Device Configuration Status Request	Not Used (set all to '0')	000	00000	CBIT_en	0	0	0	CRC	5.0µs(min)	-
Device Configuration Set	D31:16 Data to be written (16-bits)	000	00010	CBIT_en	0	0	0	CRC	6.5µs(min)	See Section 8 for operation

Operation	Data Content D31:16	Mode D15:13	Address D12:8	D7 Note 1	D6	D5	D4	CRC D3:0 Note 2	Inter Message Delay	Notes
BIT Status Request	Not Used (set all to '0')	000	00011	CBIT_en	0	0	0	CRC	5.0µs(min)	-
NVM Read	D31:21 Not Used (set all to '0') D20:16 NVM address	000	00100	CBIT_en	0	0	0	CRC	9.5µs(min)	See Section 8 for NVM memory map and access
NVM Write Data	D31:16 Data to be written (16-bits)	000	00101	CBIT_en	0	0	0	CRC	5.0µs(min)	Stored data for write ops
NVM Write	D31:21 Not Used (set all to '0') D20:16 NVM address	000	00110	CBIT_en	0	0	0	CRC	6.1ms(min)	See Section 8 for NVM memory map and access
NVM Erase	D31:21 Not Used (set all to '0') D20:16 NVM address	000	00111	CBIT_en	0	0	0	CRC	6.1ms(min)	See Section 8 for NVM memory map and access
REV	D31:16 = 0xFFFF	000	10000	1	1	1	0	CRC	5.0µs(min)	-
INV REV	D31:16 = 0x0000	000	00001	0	0	0	1	CRC	5.0µs(min)	-

Table 7.5 Command Message Format

NOTE 1: CBIT_en: 0 = inactive, 1= active. See section 7.2.6 for CBIT behaviour.

NOTE 2: In all messages to and from the sensor a 4-bit CRC (data bits D3:0) shall be added. The CRC polynomial used shall be x^4+1 . A seed value of "1010" shall be used with a calculation order MSB to LSB. The CRC shall be checked for all I/P messages. If the CRC fails then the message shall be ignored and a SPI® error message output in the next message.

7.2.2 Messages from Sensor (MISO)

Table 7.6 outlines the status message types available from the Orion™ sensor to the host:

Message Type	Mode	Operation
Rate	Data Monitor	Rate value (16-bit 2's compliment)
Acceleration Y	Data Monitor	Axis Y acceleration value (16-bit 2's compliment)
Acceleration X	Data Monitor	Axis X acceleration value (16-bit 2's compliment)
Temperature	Data Monitor	Temperature value (16-bit)
Configuration Status	Global	Request Status of device configuration e.g. BW, Range, Sense Direction etc
BIT Status	Global	Status of internal BIT flags
NVM Read (including serial number)	Global	Read of requested NVM location (16-bit data) See Section 8 for memory map
REV	Global	Revision status
INV REV	Global	Inverse revision status
NVM ECC Error	Global	NVM Parity error detected
SPI® Error	Global	SPI® clock error detected
Invalid Command	Global	SPI® request invalid

Table 7.6 Status Message Types

Table 7.7 details the bit format for messages from the Orion™ sensor:

Message Type Note 5, 6 & 7	D31:16 Data Content	D15:13 Mode Note 2	D12:8 Address	D7 CBIT Note 1	D6 Note 3	D5	D4	D3:0 CRC Note 8	Comments
Rate	Rate Data 16-bit 2's compliment	101	00000	CBIT	0	KACT Note 4		CRC	Scale Factor: see Note 9
Acceleration Y	Acceleration Y Data 16-bit 2's compliment	101	00001	CBIT	ACC Bit	KACT Note 4		CRC	Scale Factor: see Note 10
Acceleration X	Acceleration X Data 16-bit 2's compliment	101	00010	CBIT	ACC Bit	KACT Note 4		CRC	Scale Factor: see Note 10
Temperature	Temperature 1 Data 16-bit	101	00011	CBIT	0	KACT Note 4		CRC	Scale Factor and Offset: see Note 11
Configuration Status	Configuration Data 16-bit	000	00000	CBIT	0	0	0	CRC	See Section 7.2.5 for format
BIT Status	BIT Flag Status 16-bit	000	00010	CBIT	0	0	0	CRC	See Section 7.2.3 for format
NVM Normal Read	16-bit NVM Location Data	000	00011	CBIT	0	0	0	CRC	See Section 8 for memory map of NVM
NVM ECC Error	D31:16 = 0x0000	000	01000	0	0	0	0	CRC	Sent if NVM error detected
SPI® Error	D31:16 = 0x0000	000	01001	CBIT	0	0	0	CRC	Sent if Wrong No clocks or CRC failed for I/P message Note 7
Invalid SPI® Command	D31:16 = 0x0000	000	01010	CBIT	0	0	0	CRC	Sent if an invalid command was received (inc illegal NVM command Note 7)
REV	16-bit data	000	10000	1	1	1	0	CRC	See Section 7.2.4 for format
INV REV	16-bit data	000	00001	0	0	0	1	CRC	See Section 7.2.4 for format

Table 7.7 Status Message Format

NOTE 1: CBIT = 1 if CBIT is Active, 0 if CBIT is inactive. See section 7.2.6 for CBIT behaviour.

NOTE 2: If D15:14 = "01" then a fault condition has been detected.

NOTE 3: Acc Bit will be set to fail (1) if a fault with the accelerometer channels is detected. If it indicates a pass (0) then the acc channels are still operational even if bits D15:14 indicate a fault.

NOTE 4: KACT = Keep alive count; a 2 bit count that increments every data monitor message and rolls over at "11".

NOTE 5: On POR or from Reset the first message type from the sensor shall be the configuration status, for any command message.

NOTE 6: On receipt of one of the following command message types in SPI® exchange (N) the response sent in the next SPI® exchange (N+1) will be that output in SPI exchange (N-1).

NVM Write Data
 NVM Write
 NVM Erase

NOTE 7: If an invalid command message or a SPI® error message is sent by the ASIC then this message will be held until a valid status message request has been requested i.e. a message listed in section 7.2.2.

- NOTE 8:** In all messages to and from the ASIC a 4-bit CRC (data bits D3:0) shall be added. The CRC polynomial used shall be x^4+1 . A seed value of “1010” shall be used with a calculation order MSB to LSB. The CRC shall be checked for all I/P messages. If the CRC fails then the message shall be ignored and a SPI® error message output in the next message.
- NOTE 9:** The rate data shall be a 16 bit 2’s complement number, where a rate O/P of 0000h = 0°/s. Scale factor 204.8 lsb/(°/s) – Low Range, 102.4 lsb/(°/s) – High Range.
- NOTE 10:** The acceleration data shall be a 16 bit 2’s complement number, where acc output of 0000h = 0g. Scale factor 12800 lsb/g (low range), 3200 lsb/g (high range).
- NOTE 11:** The temperature data shall be a 16 bit number, as follows -40°C = 06A4h (1700₁₀), 0°C = 0852h (2130₁₀), +25°C = 0960h (2400₁₀). Scale factor 0.091°C/lsb (or 10.99 lsb/°C).

7.2.3 BIT Flag Format

The BIT status message data word is enclosed as defined in table 7.8.

BIT No.	BIT Flag	Operation
D31	Trim Data Store Data	0 = OK 1 = FAIL
D30	AGC Level BIT	0 = OK 1 = FAIL
D29	QUAD Level BIT	0 = OK 1 = FAIL
D28	DAC BIT	0 = OK 1 = FAIL
D27	QUAD Channel BIT	0 = OK 1 = FAIL
D26	RATE Channel BIT	0 = OK 1 = FAIL
D25	AGC Low BIT	0 = OK 1 = FAIL
D24	AGC High BIT	0 = OK 1 = FAIL
D23	NONINT (sine drive switch)	0 = OK 1 = FAIL
D22	ACC Y Channel BIT	0 = OK 1 = FAIL
D21	ACC X Channel BIT	0 = OK 1 = FAIL
D20	Vref Cap Check	0 = OK 1 = FAIL
D19	ACC Vdd Filter Cap BIT	0 = OK 1 = FAIL
D18	Trim Check NVM Read Error	0 = OK 1 = FAIL
D17	MEMS Ref Bit	0 = OK 1 = FAIL

Table 7.8 BIT Status Format

7.2.4 REV and INREV Format

The REV and INV REV messages can be decoded as follows:

The Device ID and revision numbers will be stored in the NVM.

REV contains devices ID and revision. The message is encoded as defined in table 7-9.

BIT No.	REV
D31:25	“1111111”
D24:22	Device ID (2:0)
D21	“1”
D20:16	Device Revision (4:0)
D15:4	“000100001110”
D3:0	CRC

Table 7.9 REV Message Format

INV REV contains devices ID and revision. The message is encoded as defined in table 7-10.

BIT No.	INV REV
D31:25	“0000000”
D24:22	Inverse of Device ID (2:0)
D21	“0”
D20:16	Inverse of Device Revision (4:0)
D15:4	“000000010001”
D3:0	CRC

Table 7.10 INV REV Message Format

7.2.5 Device Configuration

The default device configuration is stored in location 00 of the NVM (see section 8.2). To change the default device configuration see section 8.3.

This data is loaded on power-up or reset. This data can be over-ridden by a SPI® Device Configuration Set message with the following data format. A SPI® configuration selection is latched and cannot be overwritten by any further Device Configuration messages. A power or reset cycle will be required to clear the SPI® selection and reload the default NVM selection.

A device configuration status request will output the configuration currently in use within the device. The status format is defined in table 7-11.

BIT No.	Parameter	Decode
D31:28	Spare	Set to "0000"
D27:26	Gyro Bandwidth	"11" = 45Hz "10" = 55Hz "01" = 90Hz "00" = 110Hz
D25:24	ACC Y Bandwidth	"11" = 45Hz "10" = 62Hz "01" = 95Hz "00" = 190Hz
D23:22	ACC X Bandwidth	"11" = 45Hz "10" = 62Hz "01" = 95Hz "00" = 190Hz
D21	Gyro Rate Range (rate_range(0))	"1" = 150°/s "0" = 300°/s
D20	ACC Y Range	"1" = 2.5g "0" = 10g
D19	ACC X Range	"1" = 2.5g "0" = 10g
D18	ACC Y Sense Direction (see note 1)	"0" = Pos "1" = Neg
D17	ACC X Sense Direction (see note 1)	"0" = Pos "1" = Neg
D16	Gyro Sense Direction (see note 1)	"0" = +ve Rate is CW "1" = +ve Rate is ACW

Note 1: See figure 1.2 for definition of positive sense direction.

Table 7.11 Configuration Status Message Format

7.2.6 CBIT

A CBIT function can be used to check the operation of the internal control loops.

When enabled, via a SPI® message CBIT will add a fixed offset to the Rate and both Acceleration outputs, BIT_Out will be set to the fault condition and the sensor message will show a fault. The offset applied depends on the range selected. See page 5 and 6 for details.

8 NVM Memory

The NVM will be an EEPROM block with 32 locations of 16 bit data plus 6 bit ECC parity. The ECC parity bits will be able to correct single bit errors. The EEPROM block will generate two error bits; one if a single bit error is detected the other if multiple error bits are detected.

The memory will be split into two areas of 13 and 19 locations of 16 bit words.

The first area (address 00 to 0C) allows unlimited read, write or erase access by the User. The first location (address 00) is used to configure the device (e.g. Bandwidth, Range selection – see section 8.2). The remaining locations have no limitations on data content.

The second area (address 0D to 1F) is used to store calibration, setup and serial number data. The User will only be allowed read access of the serial number data (locations 0D to 10). Access to all other locations in this area are not allowed.

Section 8.3 details the sequence of messages required for each operation.

8.1 NVM Memory Map

Table 8.1 details the content and accesses allowed for each location in the NVM.

Access	Address (hex)	Access Modes (see note)	Content
Configuration	00	R,W,E	16 bits Configuration, see section 8.2
User Data	01	R,W,E	User Location 16-bit data
	02	R,W,E	User Location 16-bit data
	03	R,W,E	User Location 16-bit data
	04	R,W,E	User Location 16-bit data
	05	R,W,E	User Location 16-bit data
	06	R,W,E	User Location 16-bit data
	07	R,W,E	SSSL Use Only
	08	R,W,E	SSSL Use Only
	09	R,W,E	SSSL Use Only
	0A	R,W,E	SSSL Use Only
	0B	R,W,E	SSSL Use Only
	0C	R,W,E	SSSL Use Only
Calibration Data	0D	R	Bits 15:0 Serial Number 1
	0E	R	Bits 15:0 Serial Number 2
	0F	R	Bits 15:0 Serial Number 3
	10	R	Bits 15:0 Serial Number 4
	11	-	SSSL Use Only
	12	-	SSSL Use Only
	13	-	SSSL Use Only
	14	-	SSSL Use Only
	15	-	SSSL Use Only
	16	-	SSSL Use Only
	17	-	SSSL Use Only
	18	-	SSSL Use Only
	19	-	SSSL Use Only
	1A	-	SSSL Use Only
	1B	-	SSSL Use Only
	1C	-	SSSL Use Only
	1D	-	SSSL Use Only
	1E	-	SSSL Use Only
1F	-	SSSL Use Only	

Note: Access codes: R, W, E - Unlimited Read, Write or Erase.

Table 8.1 NVM Memory Map

8.2 Configuration Word Format

The device configuration data stored in location 00(hex) of the NVM shall have the format defined in table 8.2. Factory default settings 0FF8 (h)

BIT No.	Parameter	Decode
Bits 15:12	Spare	Set to "0000"
Bits 11:10	Gyro Bandwidth	"11" = 45Hz "10" = 55Hz "01" = 90Hz "00" = 110Hz
Bits 9:8	ACC Y Bandwidth	"11" = 45Hz "10" = 62Hz "01" = 95Hz "00" = 190Hz
Bits 7:6	ACC X Bandwidth	"11" = 45Hz "10" = 62Hz "01" = 95Hz "00" = 190Hz
Bit 5	Gyro Rate Range	"1" = 150°/s "0" = 300°/s
Bit 4	ACC Y Range	"1" = 2.5g "0" = 10g
Bit 3	ACC X Range	"1" = 2.5g "0" = 10g
Bit 2	ACC Y Sense Direction (see note 1)	"0" = Pos "1" = Neg
Bit 1	ACC X Sense Direction (see note 1)	"0" = Pos "1" = Neg
Bit 0	Gyro Sense Direction (see note 1)	"0" = +ve Rate is CW "1" = +ve Rate is ACW

Note 1: See figure 1.2 for definition of positive sense direction.

Table 8.2 Configuration Format in NVM

8.3 NVM Operations

This section defines the steps required for NVM access operations.

Read from User NVM location:

Reads from the user area of the NVM or the serial number locations.

1. NVM Read SPI® message requesting data from NVM address specified in message.

Write to User NVM location:









For the correct storage of required data the location must be erased before writing new data.

1. NVM Write Data message containing the 16-bit data to be written.
2. NVM Write command containing the 5 bit NVM address to be written to.



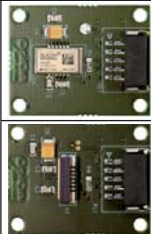

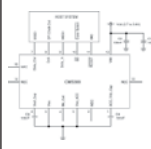
Erase of User NVM location:

1. NVM Erase message containing the 5 bit NVM address to be erased.

9 Design Tools and Resources Available

Item	Description of Resource	Part Number	Order/Download
	Orion™ Brochure: A one page sales brochure describing the key features of the Orion™ Combi sensor.	CMS300-00-0100-131	Download (www.siliconsensing.com)
	Orion™ CMS300 Datasheet: Full technical information on all Orion™ Combi Sensor part number options. Specification and other essential information for assembling and interfacing to Orion™ Combi Sensors, and getting the most out of them.	CMS300-00-0100-132	Download (www.siliconsensing.com)
	Orion™ CMS390 Datasheet: Full technical information on all Orion™ Combi Sensor part number options. Specification and other essential information for assembling and interfacing to Orion™ Combi Sensors, and getting the most out of them.	CMS390-00-0100-132	Download (www.siliconsensing.com)
	Orion™ Presentation: A useful presentation describing the features, construction, principles of operation and applications for the Orion™ Combi Sensor.	—	Download (www.siliconsensing.com)
	Orion™ evaluation boards (CMS300 & CMS390 options): Single Orion™ fitted to a small PCBA for easy customer evaluation and test purposes. Supplied with connector and flying lead.	CMS300-02-0302	Order
		CMS390-02-0305	Order
	Solid Model CAD files for Orion™ Combi Sensors: Available in .STP and .IGS file format	CMS300-00-0100-408	Download (www.siliconsensing.com)
		CMS390-00-0100-408	
	Library Parts: Useful library component files of Orion™ Combi Sensors: DxDesigner Schematic Symbols. PADS Decal (Footprint) PADS Part Type File.	—	Download (www.siliconsensing.com)
	Reference Circuit: A useful reference circuit design gerber files for the Orion™ Combi Sensor for use in host systems.	—	Download (www.siliconsensing.com)

Design Tools and Resources Available Continued

Item	Description of Resource	Part Number	Order/Download
	Interface: Off-the-peg pseudo code and a simple flowchart with message handling instructions for use as a customer aid to developing their own interface directly to a Orion™ Combi Sensor via the SPI®.	—	Download (www.siliconsensing.com)
	Questions and Answers: Some useful questions asked by customers and how we've answered them. This is an informal (uncontrolled) document intended purely as additional information.	—	Download (www.siliconsensing.com)
	RoHS compliance statement for Orion™: Orion™ is fully compliant with RoHS. For details of the materials used in the manufacture please refer to the MDS Report.	—	Download (www.siliconsensing.com)
	MDS Reports for Orion™: Material declaration required for automotive applications.	—	Download (www.siliconsensing.com)

10 Cleaning

Due to the natural resonant frequency and amplification factor ("Q") of the sensor, ultrasonic cleaning should NOT be used to clean the Orion™ Combi Sensor.

11 Soldering Information

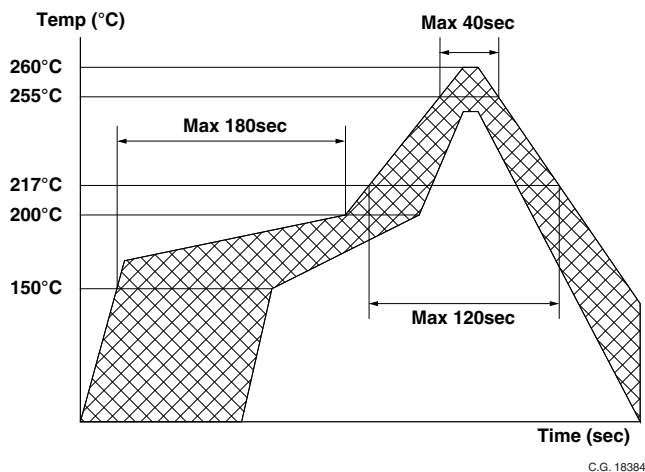

Figure 11.1 Recommended Reflow Solder Profile

12 Part Markings

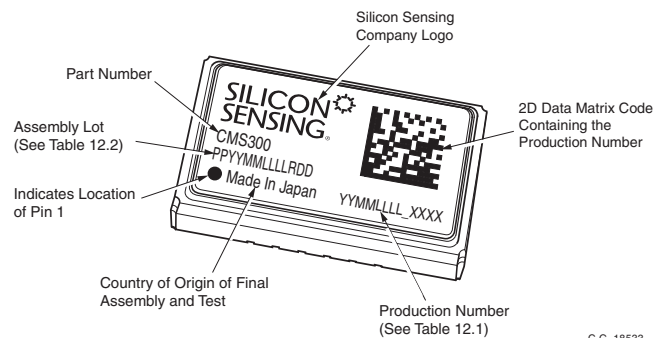

Figure 12.1 Part Marking

Item	Code	Range
Year number	YY	00 - 99
Month number	MM	01-12
Lot number	LLLL	0000 -9999
(Space)	—	—
Serial number	XXXX	0001 - 9999

Table 12.1 Production Number Code

Item	Code	Range
Configuration	PP	11 - 99
Year number	YY	00-99
Month number	MM	01-12
Lot number	LLLL	0000 -9999
Measurement times	R	0-2
Serial split	DD	00,01,--

Table 12.2 Assembly Lot Code

13 Packaging Information

Layer	Type	Quantity
CMS300	Tape and Reel	Max. 1500 pcs/ 1 Reel
Inner Bag	Aluminium Damp-proof Bag	1 Reel/Bag
Inner Box	Cardboard Box	Inner Bag x 1/Inner Box
Outer Box	Cardboard Box	Inner Box/Outer Box

Table 13.1 Packaging Information

Item	Dimension	Quantity	Material
Reel	DR2 23316C	1 Reel	PS
Emboss Tape	TE1612-091009-2	1 Roll	PS
Cover Tape	ALS-ATA 13.5mm x 480m	1 Roll	PET, PE, PS
Label for Reel	40mm x 80mm	1 label/Reel	Paper
Desiccant	FA 10g	1 Inner Bag	-
Inner Bag	0.101mm x 450mm x 530mm	1 Reel/Inner Bag	MB4800
Tray	451mm x 429mm x 55mm	2 Tray/Outer Box	-
Pad	451mm x 429mm x 20mm	3 Pad/Outer Box	-
Inner Box	413mm x 391mm x 52mm	2 Inner Box/ Outer Box	Cardboard
Outer Box	462mm x 440mm x 208mm	1 Box	Cardboard
Label for Outer Box	102mm x 127mm	1 label/Outer Box	Paper

Table 13.2 Packaging Specification

Reel Information

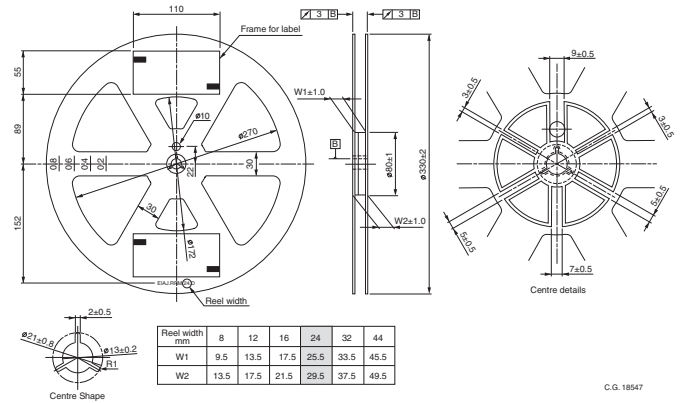

C.G. 18547

Emboss Tape Carrier Information

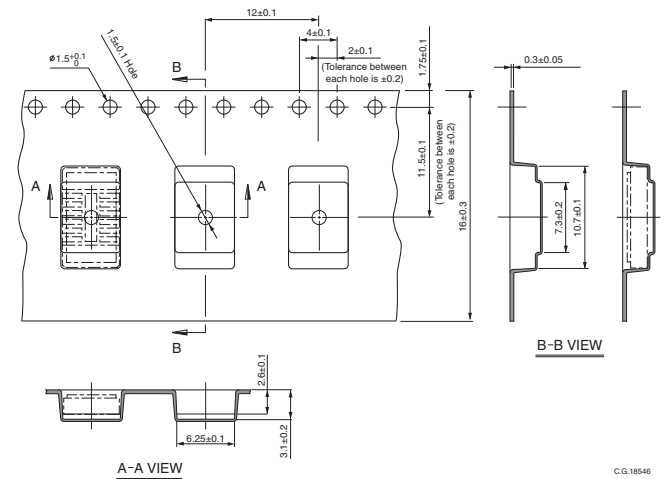

C.G. 18546

Tape Information

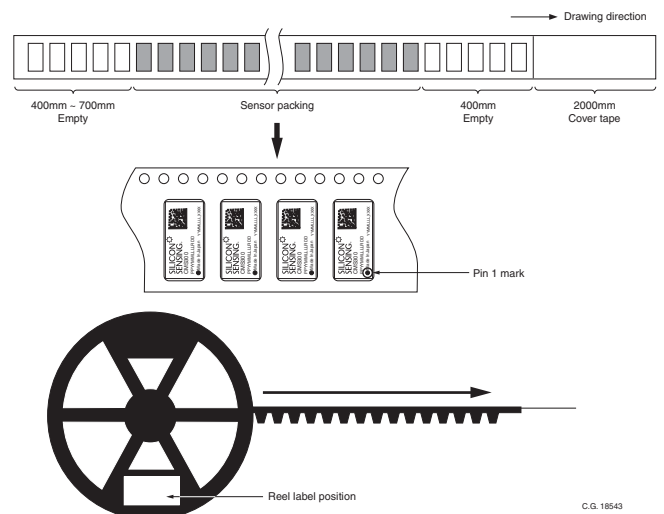

C.G. 18543

Label for Reel Information

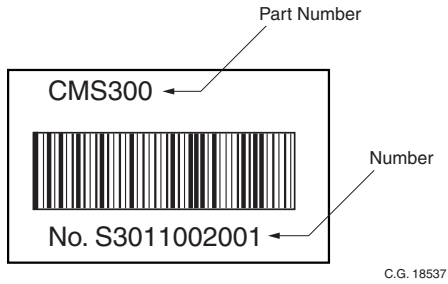

Outer Box Packing Information

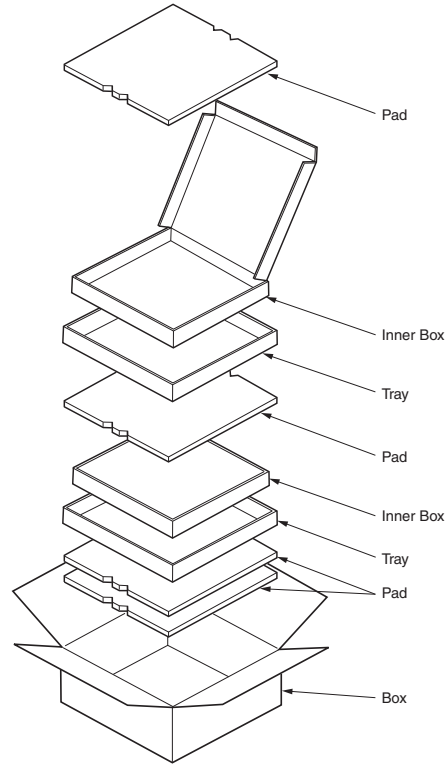

Inner Bag Packing Information

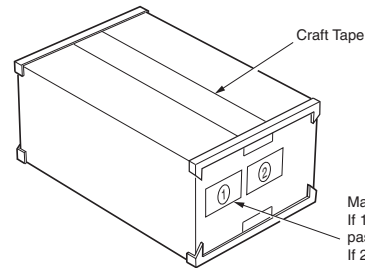
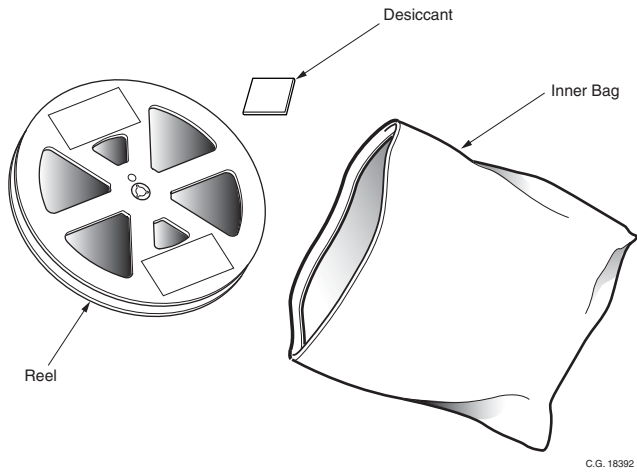

Maximum of two Reels per Outer Box.
 If 1 Reel is contained in Outer Box, label is pasted in position 1.
 If 2 Reels are contained in Outer Box, labels are pasted in positions 1 and 2.
 Each label shows packaged reel information.

C.G. 18390

Inner Box Packing Information

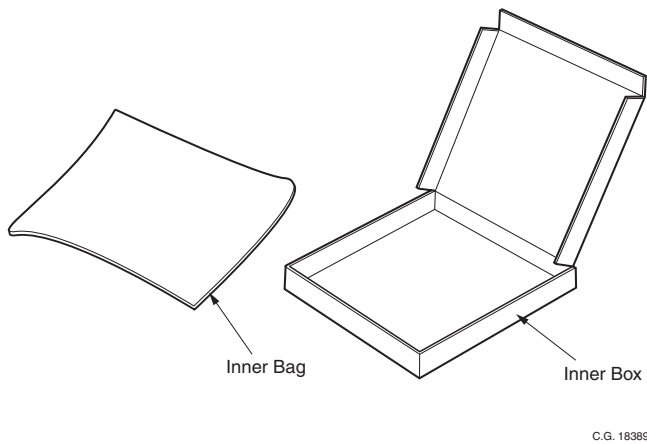

14 Internal Construction and Theory of Operation

Construction

Orion™ is available in two basic package configurations: Part Number CMS300 (flat): Relative to the plane of the host PCBA, this part measures angular velocity about a single perpendicular axis (Z) and linear acceleration about two parallel axes (X,Y).

Part Number CMS390 (orthogonal): Relative to the plane of the host PCBA, this part measures angular velocity about a single parallel axis (Z) and linear acceleration about one parallel axis (X) and one perpendicular axis (Y).

Orion™ (CMS300 and CMS390) is supplied as a PCBA surface mountable LCC ceramic packaged device. It comprises six main components; Silicon MEMS Single-Axis Angular Rate Sensor, Silicon On Glass (SOG) Dual-Axis MEMS Accelerometer, Silicon Pedestal, ASIC and the Package Base and Lid. The MEMS Sensors, ASIC and Pedestal are housed in a hermetically sealed package cavity with a nitrogen back-filled partial vacuum, this has particular advantages over sensors supplied in plastic packages which have Moisture Sensitivity Level limitations.

An exploded drawing of CMS300 showing the main components is given in Figure 14.1 below. The principles of construction for CMS390 are the same as CMS300.

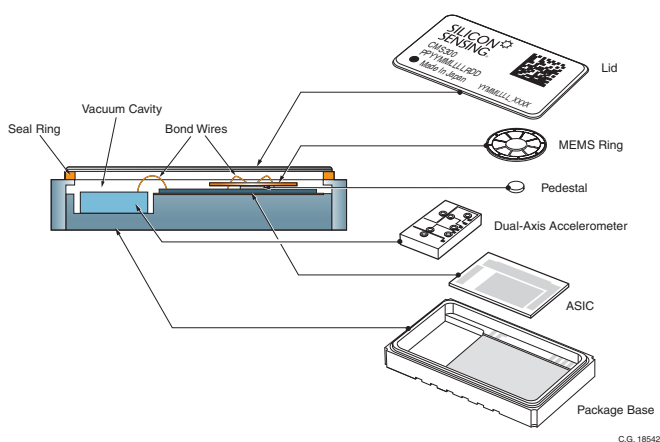

Figure 14.1 CMS300 Main Components

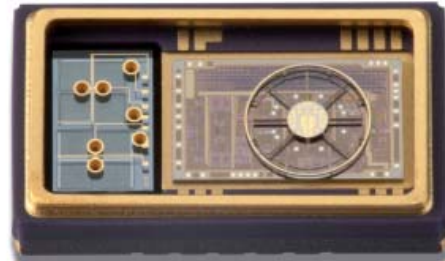

Figure 13.2 CMS300 (Lid Removed)

Silicon MEMS Ring Sensor (Gyro)

The 3mm diameter by 65µm thick silicon MEMS ring is fabricated by Silicon Sensing using a DRIE (Deep Reactive Ion Etch) bulk silicon process. The annular ring is supported in free-space by eight pairs of 'dog-leg' shaped symmetrical spokes which radiate from a central 1mm diameter solid hub.

The bulk silicon etch process and unique patented ring design enable close tolerance geometrical properties for precise balance and thermal stability and, unlike other MEMS gyros, there are no small gaps to create problems of interference and stiction. These features contribute significantly to Orion™'s bias and scale factor stability over temperature, and vibration and shock immunity. Another advantage of the design is its inherent immunity to acceleration induced rate error, or 'g-sensitivity'.

Piezoelectric (strain) film actuators/transducers are attached to the upper surface of the silicon ring perimeter and are electrically connected to bond pads on the ring hub via tracks on the spokes. These actuate or 'drive' the ring into its $\cos 2\theta$ mode of vibration at a frequency of 22kHz or detect radial motion of the ring perimeter either caused by the primary drive actuator or by the coriolis force effect when the gyro is rotating about its sensing axis. There is a single pair of primary drive actuators and a single pair of primary pick-off transducers, and two pairs of secondary pick-off transducers.

The combination of transducer technology and eight secondary pick-off transducers improves Orion™'s signal-to-noise ratio, the benefit of which is a very low-noise device with excellent bias over temperature performance.

Silicon MEMS Dual-Axis Accelerometer

The Orion™ dual-axis open loop accelerometer is a one-piece resonating silicon MEMS structure anodically bonded to top and bottom glass substrates to form a hermetically sealed Silicon on Glass (SOG) wafer sub-assembly. The same DRIE bulk silicon process as used to create the gyro in Orion™ is used to create two orthogonal finger-like spring/seismic proof mass structures, each measuring 1.8mm square, and with a resonant frequency of 2.9kHz. Figure 14.4 shows a schematic cross section through the SOG wafer.

Capacitive drive and pick-off signals are transmitted by wire bond interconnections, in through-glass vias, between the metallised transducer plates on the MEMS proof mass and the Orion™ ASIC.

Multiple inter-digitated fingers create increased capacitance thus enabling a high signal-to-noise ratio. The fingers are tapered to increase the resonant frequency and also have a high aspect ratio to provide highly stable performance. The differential gaps between the static electrode fingers and those of the proof mass provide an air squeeze film with near-critical damping.

Control of the accelerometer is handled by the Orion™ ASIC.

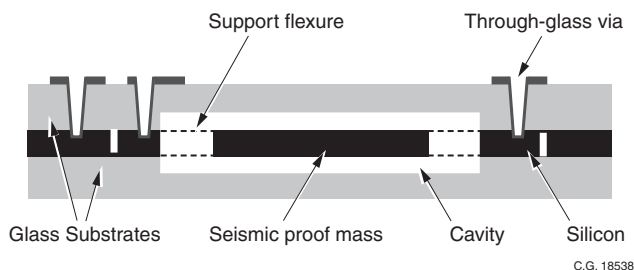

Figure 14.4 Schematic Section of the Silicon On Glass Accelerometer MEMS Wafer Sub-Assembly

Pedestal

The hub of the MEMS ring is supported above the ASIC on a 1mm diameter cylindrical silicon pedestal, which is bonded to the ring and ASIC using an epoxy resin.

ASIC

The ASIC is a 5.52mm x 3.33mm device fabricated using 0.35µm CMOS process. ASIC and MEMS are physically separate and are connected electrically by using gold bond wires and thus the ASIC has no MEMS-to-ASIC internal tracking, meaning there is reduced noise pick-up and excellent EMC performance. Gold bond wires also connect the ASIC to the internal bond pads on the Package Base.

Package Base and Lid

The LCC ceramic Package Base is a multi-layer aluminium oxide construction with internal bond wire pads connected through the Package Base via integral multi-level tungsten interconnects to a series of external solder pads. Similar integral interconnects in the ceramic layers connect the Lid to Vss, thus the sensitive elements are inside a Faraday shield for excellent EMC. Internal and external pads are electroplated gold on electroplated nickel.

The Package Base incorporates a seal ring on the upper layer onto which a Kovar® metal Lid is seam welded using a rolling resistance electrode, thus creating a totally hermetic seal. Unlike other MEMS gyro packages available on the market, Orion™ has a specially developed seam weld process which eliminates the potential for internal weld spatter. Inferior designs can cause dislodged weld spatter which affects gyro reliability due to interference with the vibratory MEMS element, especially where the MEMS structure has small gaps, unlike Orion™ with its large gaps as described above.

Theory of Operation (Gyro)

Orion™ rate sensor is a solid-state device and thus has no moving parts other than the deflection of the ring itself. It detects the magnitude and direction of angular velocity by using the 'coriolis force' effect. As the gyro is rotated coriolis forces acting on the silicon ring cause radial movement at the ring perimeter.

There are eight actuators/transducers distributed evenly around the perimeter of the silicon MEMS ring. Located about its primary axes (0° and 90°) are a single pair of 'primary drive' actuators and a single pair of 'primary pick-off' transducers. Located about its secondary axes (45° and 135°) are two pairs of 'secondary pick-off' transducers.

The 'primary drive' actuators and 'primary pick-off' transducers act together in a closed-loop system to excite and control the ring primary operating vibration amplitude and frequency (22kHz). Secondary 'pick-off' transducers detect radial movement at the secondary axes, the magnitude of which is proportional to the angular speed of rotation and from which the gyro derives angular rate. The transducers produce a double sideband, suppressed carrier signal, which is demodulated back to a baseband. This gives the user complete flexibility over in system performance, and makes the transduction completely independent of DC or low frequency parametric conditions of the electronics.

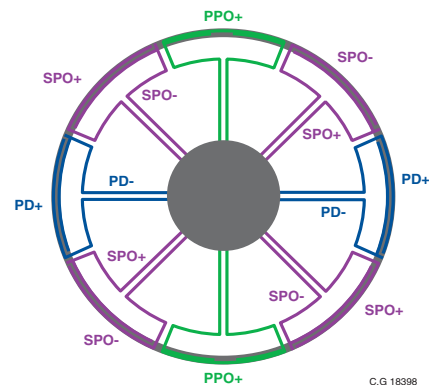

Figure 14.3(a)

Referring to Figures 14.3(a) to 14.3(d)

Figure 14.3(a) shows the structure of the silicon MEMS ring. Figure 14.3(b) shows the ring diagrammatically, the spokes, actuators and transducers removed for clarity, indicating the Primary Drive actuators (single pair), Primary Pick-Off transducers (single pair) and Secondary Pick-Off transducers (two pairs). In Figure 14.3(b) the annular ring is circular and is representative of the gyro when unpowered.

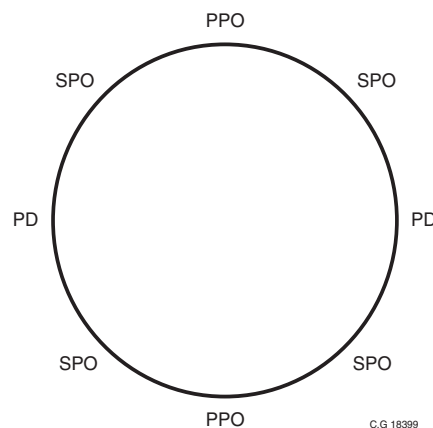

Figure 14.3(b)

When powered-up the ring is excited along its primary axes using the Primary Drive actuators and Primary Pick-Off transducers acting in a closed-loop control system within the ASIC. The circular ring is deformed into a 'Cos2θ' mode which is elliptical in form and has a natural frequency of 22kHz. This is depicted in Figure 14.3(c). In Figure 14.3(c) the gyro is powered-up but still not rotating. At the four Secondary Pick-Off nodes located at 45° to the primary axes on the ring perimeter there is effectively no radial motion.

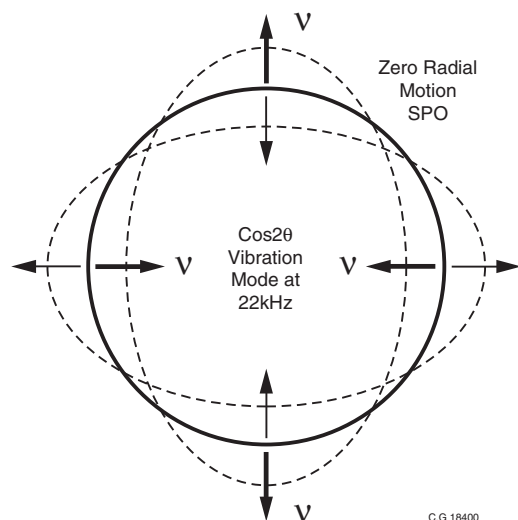

Figure 14.3(c)

If the gyro is now subjected to applied angular rate, as indicated in Figure 14.3(d), then this causes the ring to be subjected to coriolis forces acting at a tangent to the ring perimeter on the primary axes. These forces in turn deform the ring causing radial motion at the Secondary Pick-Off transducers. It is the motion detected at the Secondary Pick-off transducers which is proportional to the applied angular rate.

The DSBSC signal is demodulated with respect to the primary motion, which results in a low frequency component which is proportional to angular rate. All of the gyro control circuitry is hosted in the ASIC. A block diagram of the ASIC functions is given in Figure 1.1 in Section 1.

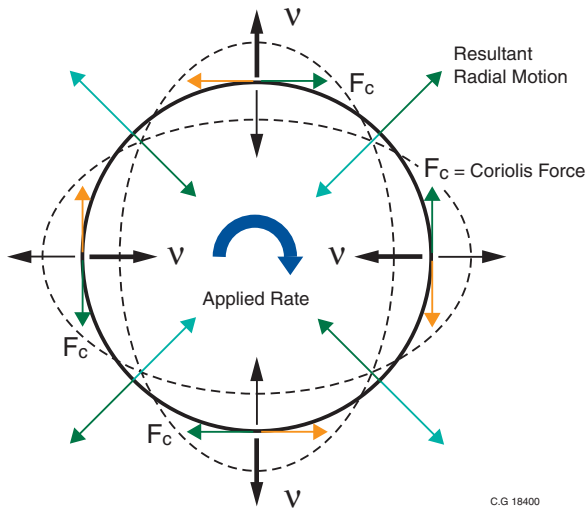

Figure 14.3(d)

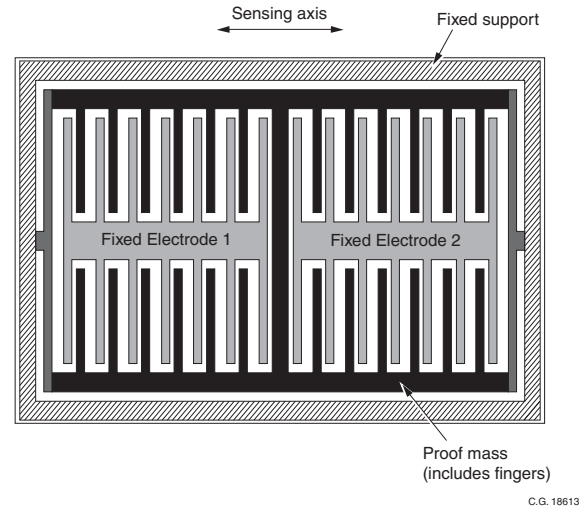

Figure 14.5(a) Schematic of Accelerometer Structure

Theory of Operation (Accelerometer)

The accelerometer contains a seismic ‘proof mass’ with multiple fingers suspended via a ‘spring’, all of which is formed in the silicon MEMS structure. The proof mass is anodically bonded to the top and bottom glass substrates and thereby fixed to the Orion™ Package Base.

When the Orion™ sensor is subjected to a linear acceleration along its sensitive axis the proof mass tends to resist motion due to its own inertia, therefore the mass and it’s fingers becomes displaced with respect to the interdigitated fixed electrode fingers. Air between the fingers provides a damping effect. This displacement induces a differential capacitance between the moving and fixed silicon fingers which is proportional to the applied acceleration.

Capacitor plate groups are electrically connected in pairs at the top and bottom of the proof mass. In-phase and anti-phase waveforms are applied by the Orion™ ASIC separately to the ‘left’ and ‘right’ finger groups. The demodulated waveforms provide a signal output proportional to linear acceleration.

Figures 14.5(a) and 14.5(b) provide schematics of the accelerometer structure and control loop respectively.

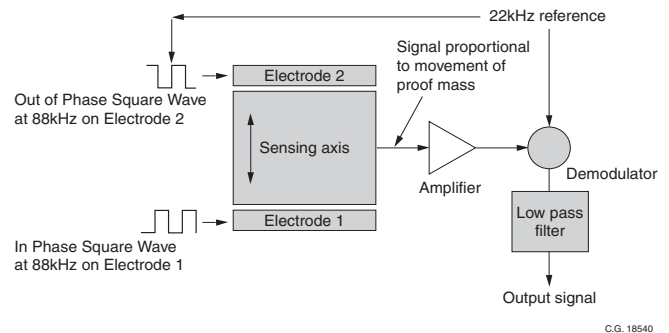

Figure 14.5(b) Schematic of Accelerometer Control Loop

15 Patent Applications

The following patent applications have been filed for the Orion™ Combi Sensors:

Patent Application	Status
US5226321	Granted
US5419194	Granted
US6698271	Granted
WO2009/119205	Patent Pending

Notes

Silicon Sensing Systems Limited
Clifford Road Southway
Plymouth Devon
PL6 6DE United Kingdom
T: +44 (0)1752 723330
F: +44 (0)1752 723331
E: sales@siliconsensing.com
W: siliconsensing.com

Silicon Sensing Systems Japan Limited
1-10 Fuso-Cho
Amagasaki
Hyogo 6600891 Japan
T: +81 (0)6 6489 5868
F: +81 (0)6 6489 5919
E: sssj@spp.co.jp
W: siliconsensing.com

Specification subject to change without notice.

© Copyright 2013
Silicon Sensing Systems Limited
All rights reserved.

Printed in England 08/2013
Date 06/08/2012

CMS300-00-0100-132 Rev 8
DCR No. 710005183